



11/14/2008

WD90U



Item No.	Part No.	UPC Number	Description	Qty Shipped per order	Qty.
1	WD90S-100	883099036699	GASKET, CYLINDER BLOCK	1	1
2	WD90S-101	883099036743	DOWEL PINΦ8×12	2	2
3	WD90S-102	883099036774	CYLINDER BLOCK	1	1
4	WD90S-103	883099036804	RECTANGLE RING B	1	1
5	WD90S-104	883099036811	BOLT M6×22	2	2
6	WD90S-105	883099036835	GASKET, CYLINDER HEAD	1	1
7	WD90S-106	883099036972	DOWEL PINΦ8×14	2	2
8	WD90S-107	883099037245	BUSH	1	1
9	WD90S-108	883099037689	RECTANGLE RING C	1	1
10	WD90S-109	883099037801	GASKET, RECTANGLE RING A	1	1
11	WD90S-110	883099037818	RECTANGLE RING A	1	1
12	WD90S-111	883099037955	LEFT COVER, CYLINDER HEAD	1	1
13	WD90S-112	883099037962	GASKET, CYLINDER HEAD LEFT COVER	1	1
14	WD90S-113	883099037979	STUD BOLT M6×22	2	2
15	WD90S-114	883099038013	SEALING WASHER, VALVE CAP	2	2
16	WD90S-115	883099038099	VALVE CAP	2	2

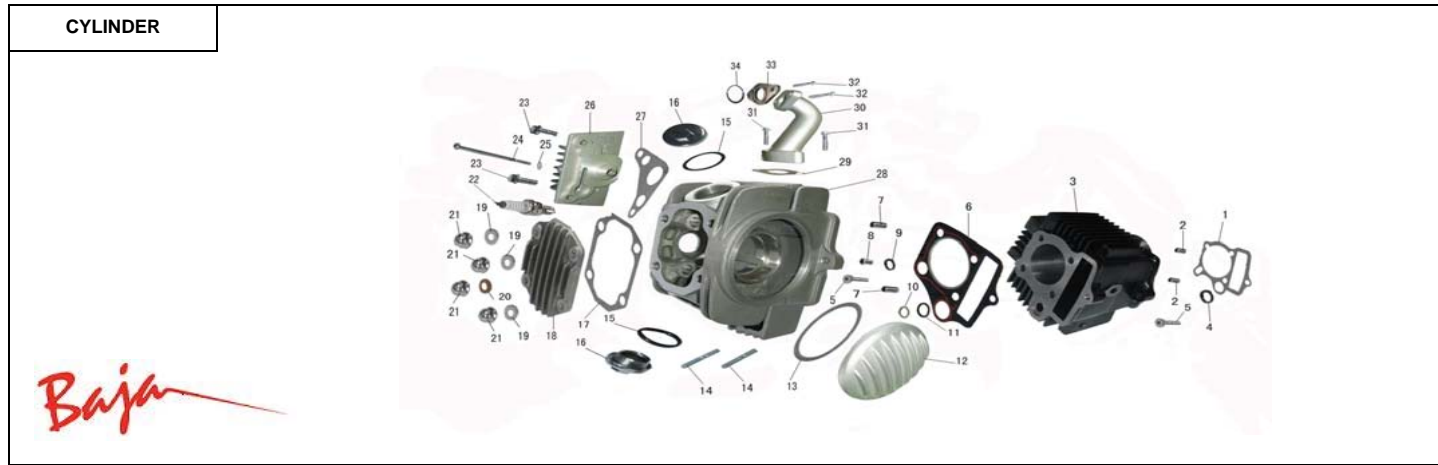

Item No.	Part No.	UPC Number	Description	Qty Shipped per order	Qty.
17	WD90S-116	883099038235	GASKET, CYLINDER HEAD COVER	1	1
18	WD90S-117	883099038259	CYLINDER HEAD COVER	1	1
19	WD90S-118	883099038266	STEEL GASKETΦ6×13×2	3	3
20	WD90S-119	883099038273	COPPER GASKETΦ6×13×2	1	1
21	WD90S-120	883099038280	NUT, CYLINDER HEAD	2	4
22	WD90S-121	883099038297	SPARK PLUG A7TC	1	1
23	WD90S-122	883099038310	BOLT M6×20	2	2
24	WD90S-123	883099038327	BOLT M6×110	1	1
25	WD90S-124	883099038334	ALUMINUM GASKETΦ6×13×2	1	1
26	WD90S-125	883099038341	RIGHT COVER, CYLINDER HEAD	1	1
27	WD90S-126	883099038358	SEALING WASHER, CYLINDER RIGHT COVER	1	1
28	WD90S-127	883099038365	CYLINDER HEAD	1	1
29	WD90S-128	883099038372	GASKET, INLET PIPE	1	1
30	WD90S-129	883099038402	INLET PIPE	1	1
31	WD90S-130	883099038419	HEXANGULAR BOLT M6×30	2	2
32	WD90S-131	883099038426	HEXANGULAR BOLT M6×25	2	2

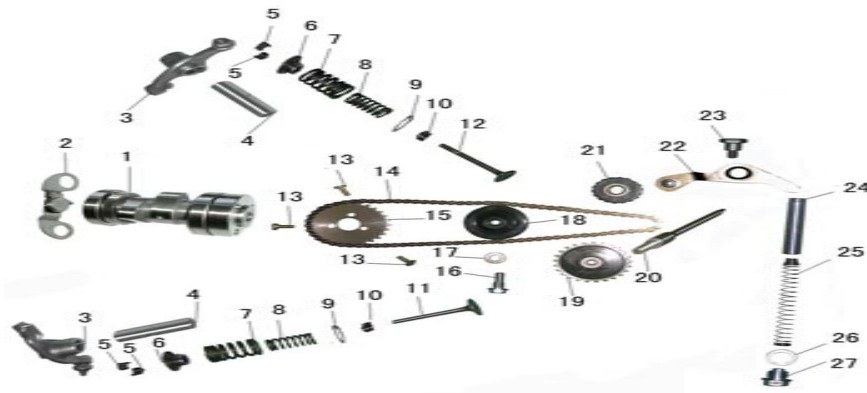
VALVES					
					
Item No.	Part No.	UPC Number	Description	Qty Shipped per order	Qty.
1	WD90S-134	883099038464	CAM SHAFT COMP C100	1	1
2	WD90S-135	883099038556	POSITION LIMITING PLATE, CAM SHAFT C100	1	1
3	WD90S-136	883099038860	ROCKER ARM, VALVE	1	2
4	WD90S-137	883099038877	ROCKER ARM AXLE, VALVE	2	2
5	WD90S-138	883099038907	COTTER, VALVE	2	4
6	WD90S-139	883099038914	RETAINER, VALVE SPRING	2	2
7	WD90S-140	883099038938	OUTER RETAINER, VALVE SPRING	2	2
8	WD90S-141	883099038976	INNER RETAINER, VALVE SPRING	2	2
9	WD90S-142	883099039003	OUTER RETAINER RING, VALVE SPRING	2	2
10	WD90S-143	883099039034	SEAL, VALVE STEM	2	2
11	WD90S-144	883099039089	VALVE INLET	1	1
12	WD90S-145	883099039096	VALVE EXHAUST	1	1
13	WD90S-146	883099039119	BOLT M5×12	3	3
14	WD90S-147	883099039133	TIMING CHAIN	1	1
15	WD90S-148	883099039188	DRIVEN SPROCKET, TIMING 28T	1	1
16	WD90S-149	883099039232	CORE AXLE, CHAIN GUIDE ROLLER	1	1

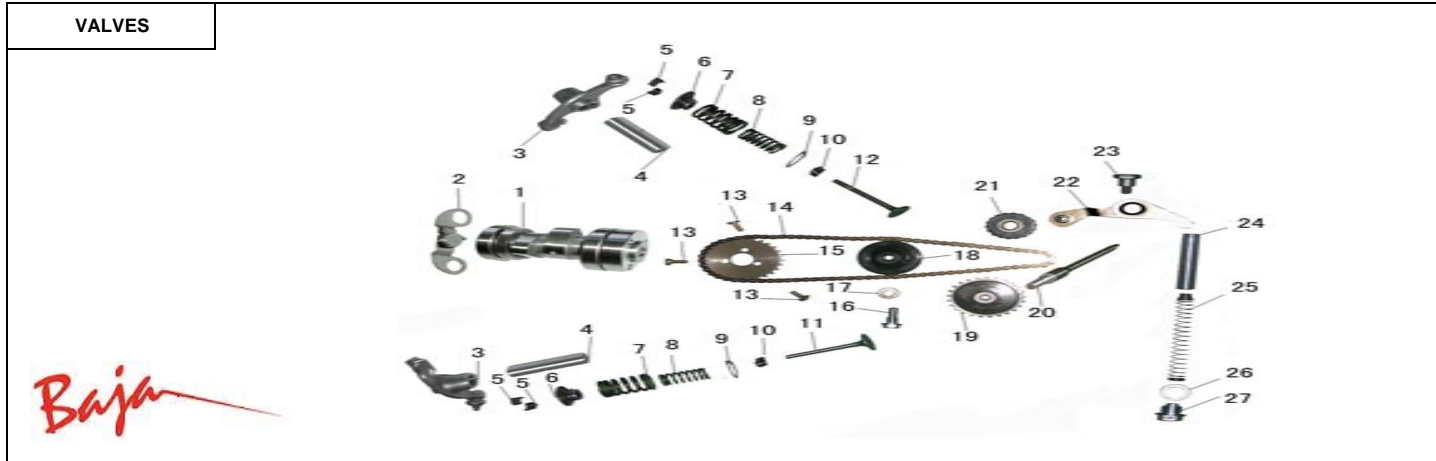

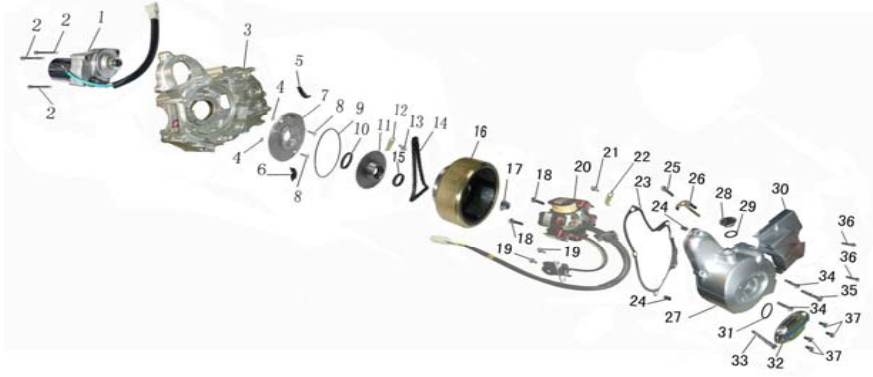

Item No.	Part No.	UPC Number	Description	Qty Shipped per order	Qty.
17	WD90S-150	883099039287	ALUMINUM GASKETΦ12×20×2	1	1
18	WD90S-151	883099039300	CHAIN GUIDE ROLLER	1	1
19	WD90S-152	883099039317	SPROCKET, OIL PUMP	1	1
20	WD90S-153	883099039348	SPROCKET AXLE, OIL PUMP	1	1
21	WD90S-154	883099039362	TENSION ROLLER, TIMING CHAIN	1	1
22	WD90S-155	883099039386	TENSION ARM	1	1
23	WD90S-156	883099039416	CORE AXLE, TENSION ARM	1	1
24	WD90S-157	883099039478	TENSION PUSH ROD ASSY, TIMING CHAIN	1	1
25	WD90S-158	883099039508	TENSION PUSH ROD SPRING, SPROCKET	1	1
26	WD90S-159	883099039515	ALUMINUM GASKETΦ14×20×2	1	1
27	WD90S-160	883099039546	SEALING BOLT PLUG	1	1

MAGNETO					
Item No.	Part No.	UPC Number	Description	Qty Shipped per order	Qty.
1	WD90S-161	883099039584	STARTING MOTOR	1	1
2	WD90S-162	883099039652	BOLT M6×48	3	3
3	WD90S-163	883099039669	L CRANKCASE ASSY	1	1
4	WD90S-164	883099039683	O-RING 6.5×1.9	2	2
5	WD90S-165	883099039713	GUIDE PLATE, STARTING SPROCKET	1	1
6	WD90S-166	883099039737	TENSION PLATE, STARTING SPROCKET	1	1
7	WD90S-167	883099039744	OIL ISOLATED DISC	1	1
8	WD90S-168	883099039812	BOLT M6×16	2	2
9	WD90S-169	883099039836	O-RING 106.8×2	1	1
10	WD90S-170	883099039850	OIL SEALING 30×42×4.5	1	1
11	WD90S-171	883099039867	BIG SPROCKET	1	1
12	WD90S-172	883099039874	GEAR PLATE	1	1
13	WD90S-173	883099039911	HEXANGULAR BOLT M6×12	1	1
14	WD90S-174	883099039942	STARTING CHAIN	1	1
15	WD90S-175	883099039980	OIL SEALING 18.5×30×5	1	1
16	WD90S-176	883099040115	ROTATOR, GENERATOR	1	1

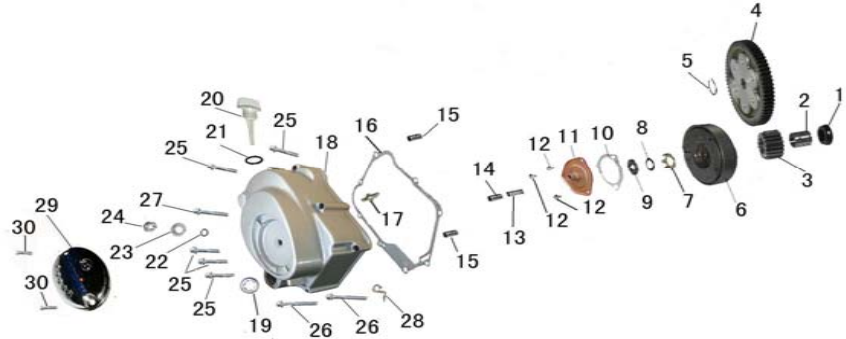

MAGNETO					
Item No.	Part No.				
17	WD90S-177	883099040177	BOLT, GENERATOR	1	1
18	WD90S-178	883099040207	BOLT M6×20	2	2
19	WD90S-179	883099040306	BOLT M5×12	2	2
20	WD90S-180	883099040351	STATOR, GENERATOR	1	1
21	WD90S-181	883099040436	HEXANGULAR BOLT M5×6	1	1
22	WD90S-182	883099040467	CLAMPER, WRIE	1	1
23	WD90S-183	883099040498	GASKET, L.CRANKCASE	1	1
24	WD90S-184	883099040542	DOWEL PINΦ8×12	2	2
25	WD90S-185	883099040580	BOLT M6×12	1	1
26	WD90S-186	883099040603	GENERATOR CLAMPER	1	1
27	WD90S-187	883099040610	L. FRONT COVER	1	1
28	WD90S-188	883099040627	OBSERVE HOLE COVER B	1	1
29	WD90S-189	883099040634	O-RING 13.2×2.65	1	1
30	WD90S-190	883099043963	L. REAR COVER	1	1
31	WD90S-191	883099044175	O-RING 27.4×2.4	1	1
32	WD90S-192	883099044359	LEFT LOGO COVER	1	1

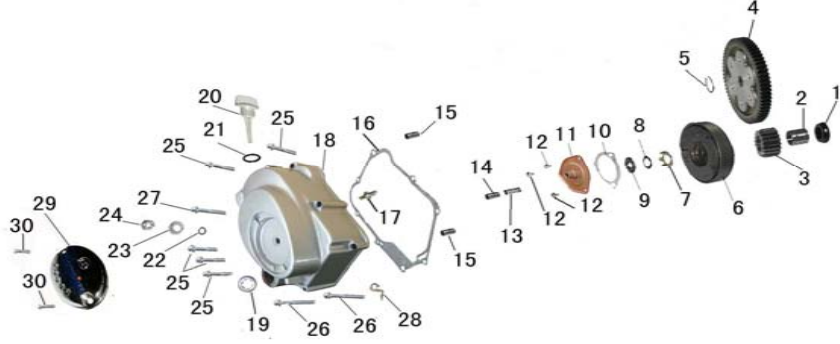

CLUTCH					
					
Item No.	Part No.	UPC Number	Description	Qty Shipped per order	Qty.
1	WD90S-198	883099044410	BUSH, ISOLATED COLLAR	1	1
2	WD90S-199	883099044427	BUSH, DRIVING GEAR	1	1
3	WD90S-200	883099044465	DRIVING GEAR	1	1
4	WD90S-201	883099044687	DRIVEN GEAR ASSY	1	1
5	WD90S-202	883099044854	SPRING CIRCLIP 17	1	1
6	WD90S-203	883099044861	CLUTCH(AUTOMATIC DRIVING)	1	1
7	WD90S-204	883099044953	THRUST GASKET	1	1
8	WD90S-205	883099045011	DICK GASKET	1	1
9	WD90S-206	883099045127	ROUND NUT M14x1	1	1
10	WD90S-207	883099045226	SEALING GASKET, CLUTCH END COVER	1	1
11	WD90S-208	883099045264	CLUTCH END COVER	1	1
12	WD90S-209	883099045356	SCREW M5x8	3	3
13	WD90S-210	883099045363	SPRING, OIL TUBE	1	1
14	WD90S-211	883099045370	OIL TUBE	1	1
15	WD90S-212	883099045387	DOWEL PINφ8x12	2	2
16	WD90S-213	883099045424	GASKET, L. CRANKCASE COVER	1	1

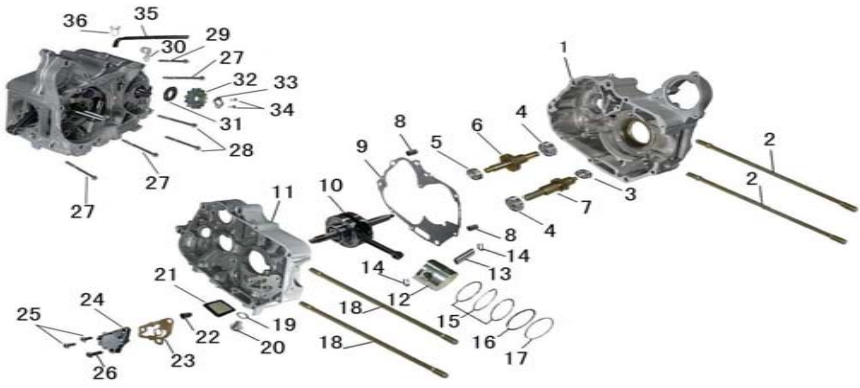
CLUTCH					
					
					
Item No.	Part No.	UPC Number	Description	Qty Shipped per order	Qty.
17	WD90S-214	883099045462	ADJUSTING BOLT	1	1
18	WD90S-215	883099045486	R. CRANKCASE COVER ASSY	1	1
19	WD90S-216	883099045509	OBSERVE HOLE, OIL	1	1
20	WD90S-217	883099045547	OIL GAUGE	1	1
21	WD90S-218	883099045554	O-RING 18x3.5	1	1
22	WD90S-219	883099045561	O-RING 7.5x1.8	1	1
23	WD90S-220	883099045578	STEEL GASKET 8x16x2.5	1	1
24	WD90S-221	883099045585	HEXANGULAR NUT M8	1	1
25	WD90S-222	883099045615	BOLT M6x40	3	5
26	WD90S-223	883099045660	BOLT M6x80	2	2
27	WD90S-224	883099045707	BOLT M6x65	1	1
28	WD90S-225	883099045721	WIRE CLAMPER	1	1
29	WD90S-226	883099045752	R. LOGO COVER	1	1
30	WD90S-227	883099046001	BOLT M6x16	2	2

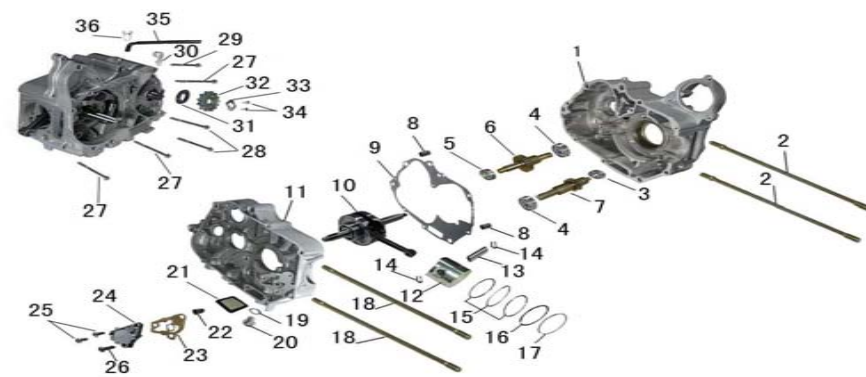
CRANKCASE					
Item No.	Part No.	UPC Number	Description	Qty Shipped per order	Qty.
1	WD90S-228	883099046018	L. CRANKCASE BODY ASSY	1	1
2	WD90S-229	883099046025	CYLINDER BOLT B M6×196	2	2
3	WD90S-230	883099046032	BEARING 6001	1	1
4	WD90S-231	883099046049	BEARING 6203	2	2
5	WD90S-232	883099046056	BEARING 6201	1	1
6	WD90S-233	883099046063	COUNTERSHAFT ASSY	1	1
7	WD90S-234	883099046070	MAIN SHAFT ASSY	1	1
8	WD90S-235	883099046087	DOWEL PINΦ10×14	2	2
9	WD90S-236	883099046094	GASKET, CRANKCASE	1	1
10	WD90S-237	883099046148	CRANKSHAFT CONNECT ROD	1	1
11	WD90S-238	883099046162	R.CRANKCASE ASSY	1	1
12	WD90S-239	883099046247	PISTON	1	1
13	WD90S-240	883099046254	PISTON PIN	1	1
14	WD90S-241	883099046261	CIRCLIP, PISTON PIN	2	2
15	WD90S-242	883099046278	PISTON RINGS	1	1
16	WD90S-243	883099046285	PISTON RING 2	1	1

CRANKCASE					
					
					
Item No.	Part No.	UPC Number	Description	Qty Shipped per order	Qty.
17	WD90S-244	883099046315	PISTON RING 1	1	1
18	WD90S-245	883099046322	CYLINDER BOLT A M6×188	2	2
19	WD90S-246	883099046339	ALUMINUM GASKET 12.2×20×2	1	1
20	WD90S-247	883099046346	OIL DRAINING PLUG	1	1
21	WD90S-248	883099046353	OIL FILTER SCREEN	1	1
22	WD90S-249	883099046377	AXLE COLLAR, OIL PUMP SPROCKET	1	1
23	WD90S-250	883099046384	GASKET,OIL PUMP	1	1
24	WD90S-251	883099046391	OIL PUMP ASSY	1	1
25	WD90S-252	883099046407	SCREW M6×16	2	2
26	WD90S-253	883099046414	SCREW M6×22	1	1
27	WD90S-254	883099046421	BOLT M6×60	3	3
28	WD90S-255	883099046438	BOLT M6×65	2	2
29	WD90S-256	883099046445	BOLT M6×50	1	1
30	WD90S-257	883099046452	CLAMPER, BREATHER TUBE	1	1
31	WD90S-258	883099046469	OIL SEALING TC 17 29 5, COUNTERSHAFT	1	1
32	WD90S-259	883099046476	DRIVING SPROCKET	1	1

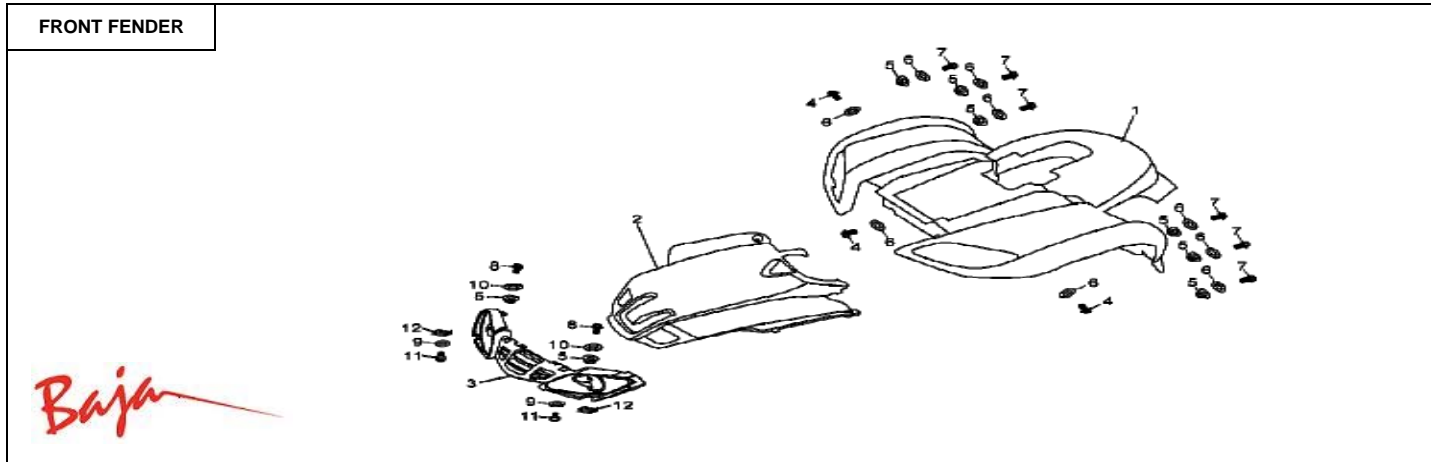

Item No.	Part No.	UPC Number	Description	Qty per Order	Qty.
1	90U-112	842645021640	FENDER, FRONT	1	1
2	90U-113	842645021657	COVER UPPER FRONT	1	1
3	90U-114	842645021664	COVER LOWER FRONT	1	1
4	90U-115	842645021671	BOLT M6 × 20	2	3
5	90U-116	842645021688	NUT M6	6	10
6	90U-117	842645021695	WASHER 6	5	9
7	90U-118	842645021701	BOLT, WITH WASHER M6 × 20	4	6
8	90U-119	842645021718	BOLT M6 × 16	1	2
9	90U-120	842645021732	WASHER 4	1	2
10	90U-121	842645021749	WASHER 6	1	2
11	90U-122	842645021756	SCREW ST3.5 × 16	1	2
12	90U-123	842645021763	CLIP NUT	1	2

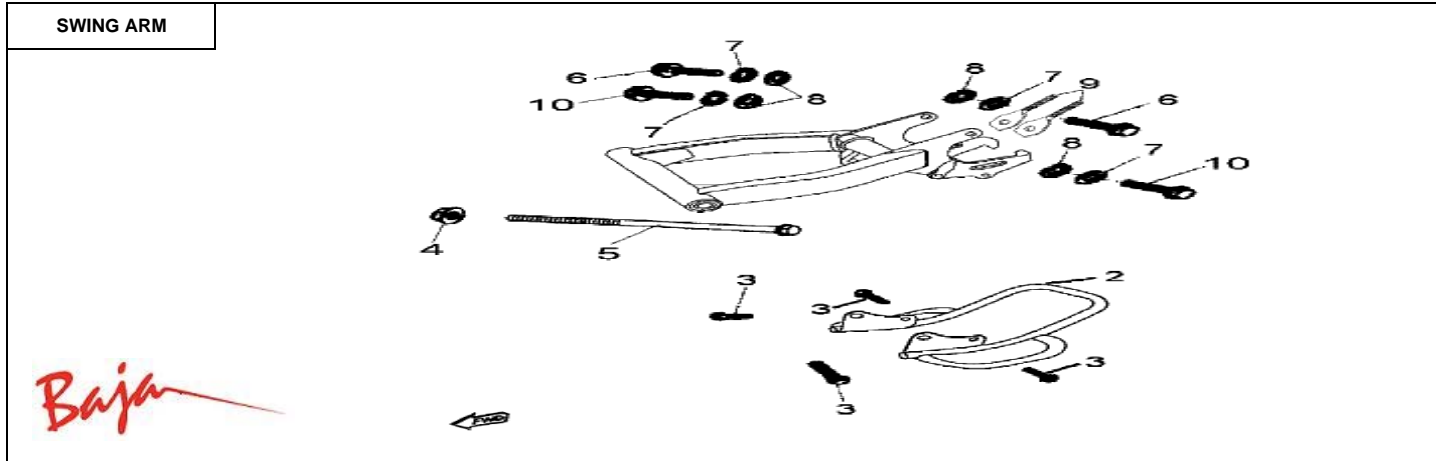



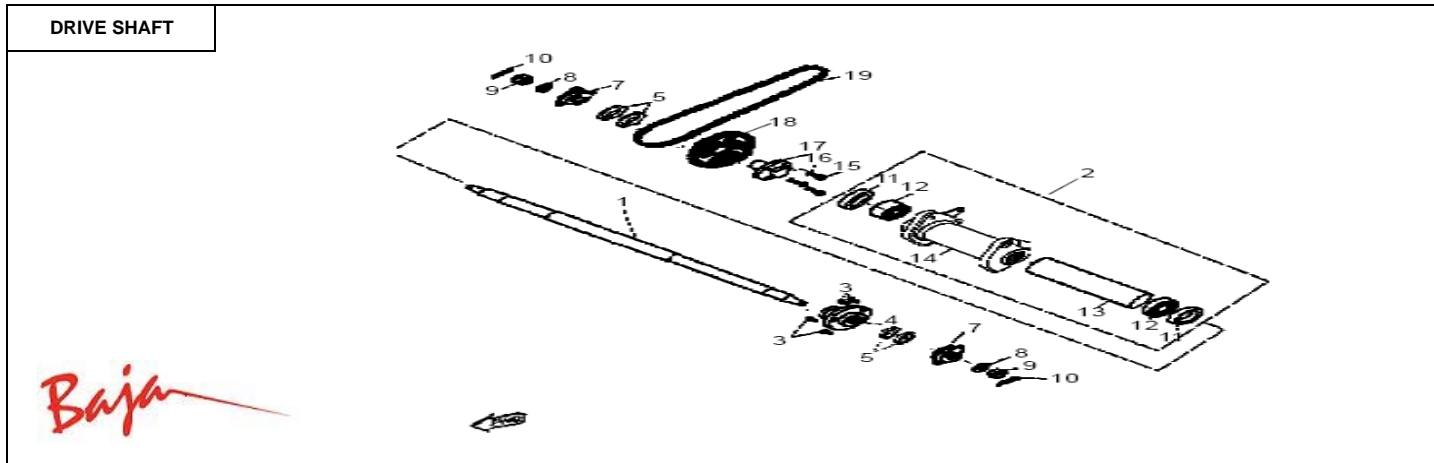

Item No.	Part No.	UPC Number	Description	Qty per Order	Qty.
1	90U-130	842645021831	SWINGARM	1	1
2	90U-131	842645021848	COVER, DISC BRAKE PROTECTION	1	1
3	90U-132	842645021855	BOLT M8× 25	3	4
4	90U-133	842645021862	NUT M14 × 1.5	1	1
5	90U-134	842645021879	SWING ARM AXLE	1	1
6	90U-135	842645021886	BOLT M10× 30	1	2
7	90U-136	842645021893	WASHER 12	3	4
8	90U-137	842645021909	NUT M10× 1.25	3	4
9	90U-138	842645021916	CHAIN ADJUSTER	1	2
10	90U-139	842645021923	BOLT M10× 25	1	2



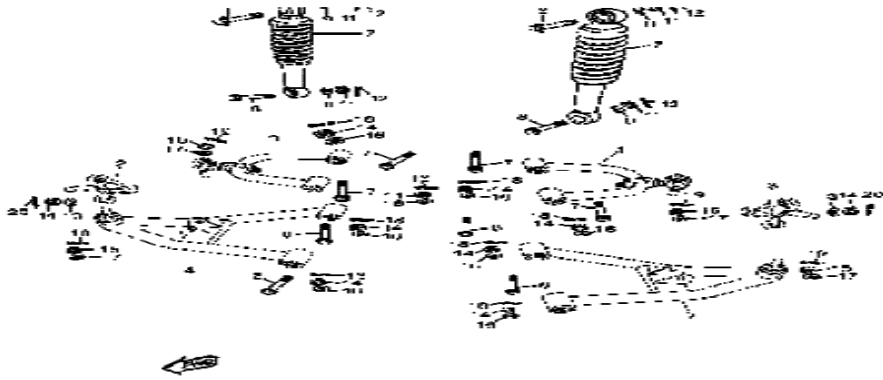

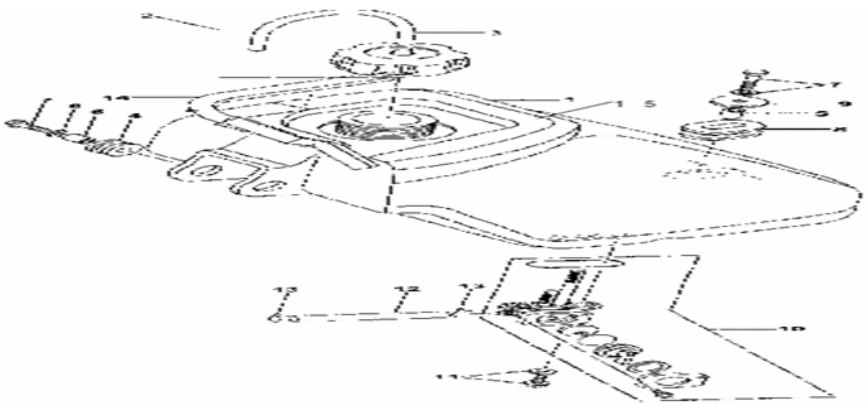

Item No.	Part No.	UPC Number	Description	Qty per Order	Qty.
1	90U-147	842645022043	AXLE, REAR	1	1
2	90U-148	842645022050	COVER PART, REAR AXLE	1	1
3	90U-149	842645022067	BOLT M8× 20	3	4
4	90U-150	842645022074	BRAKE DISH JOINT	1	1
5	90U-151	842645022081	NUT M30× 1.5	3	4
7	90U-152	842645022135	CONNECTING PLATE WHEEL HUB	1	2
8	90U-153	842645022159	WASHER	1	2
9	90U-154	842645022166	NUT M14× 1.5	1	2
10	90U-155	842645022173	COTTER PIN 3.2 × 32	1	2
11			OIL SEAL 30× 55× 12	1	2
12			BEARING 6006-2RS	1	2
13			INNER SLEEVE, REAR AXLE	1	1
14			SEAT, BEARING	1	1
15	90U-156	842645022203	BOLT M8× 20	2	3
16	90U-157	842645022210	SPRING WASHER 8	2	3

STEERING COLUMN					
Item No.	Part No.	UPC Number	Description	Qty per Order	Qty.
1	90U-167	842645022388	STEERING SHAFT, ASSEMBLY	1	1
2	90U-168	842645022395	HOLDER, STEERING SHAFT	1	2
3	90U-169	842645022401	CLIP	1	1
4	90U-170	842645022418	BOLT M8×60	1	1
5	90U-171	842645022425	WASHER, LOCK 1	1	1
6	90U-172	842645022449	BUSHING	1	1
7	90U-173	842645022456	WASHER, 12	1	1
8	90U-174	842645022463	NUT, M12×1.25	1	1
9	90U-175	842645022548	PIN, COTTER 2.5×30	1	1
10	90U-176	842645022562	TIE-ROD ASSEMBLY STEERING	1	2
11	90U-177	842645022579	HOLDER, HANDLEBAR	1	1SET
12	90U-178	842645022586	BOLT M8×60	3	4

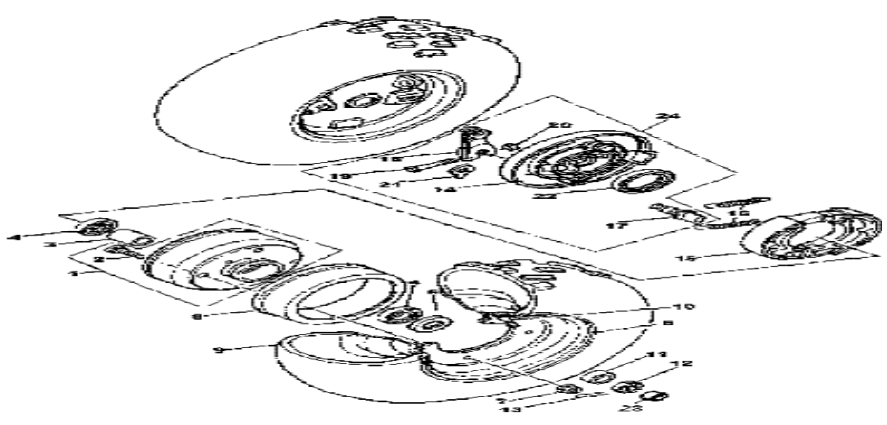
FRONT SUSPENSION					
					
					
Item No.	Part No.	UPC Number	Description	Qty per Order	Qty.
1	90U-179	842645022593	UPPER, F. SWING ARM	1	2
2	90U-180	842645022609	STEERING KNUCKLE ASSY (RIGHT)	1	1
3	90U-181	842645022616	STEERING KNUCKLE ASSY (LEFT)	1	1
4	90U-182	842645022623	R.LOWER SWING ARM	1	1
5	90U-183	842645022630	R.LOWER SWING ARM	1	1
6	90U-184	842645022647	LOWER SWING ARM BOLT 10 × 68	3	4
7	90U-185	842645022654	SHOCK, FRONT	1	2
8	90U-186	842645022661	F.ABSORBER UPPER (LOWER) BOLT 10×55	3	4
9	90U-187	842645022685	PLATE WASHER	3	4
10	90U-188	842645022692	NUT M8	3	4
11	90U-189	842645022722	COTTER PIN 2 × 25	3	4
12	90U-190	842645022739	WASHER 12	1	2
13	90U-191	842645022753	NUT 8	5	8
14	90U-192	842645022760	NUT 12	3	4
15	90U-193	842645022777	WASHER 8	5	8

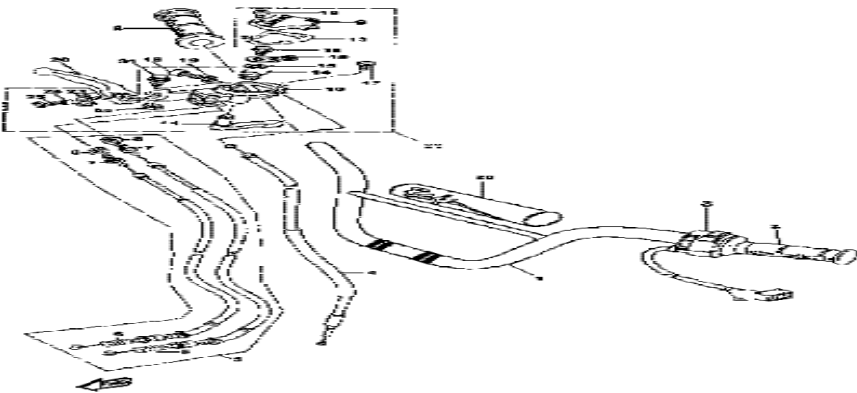

FUEL TANK					
					
					
Item No.	Part No.	UPC Number	Description	Qty per Order	Qty.
1	90U-198	842645022821	FUEL TANK COMP.	1	1
2	90U-199	842645022838	FUEL CAP	1	1
3	90U-200	842645022845	VENT TUBE, FUEL CAP	1	1
4	90U-201	842645023118	FUEL COCK ASSY	1	1
5	90U-202	842645023149	BOLT M5 ×16	1	2
6	90U-203	842645023156	GASKET, FUEL TANK(I)	1	2
7	90U-204	842645023231	COLLAR	1	1
8	90U-205	842645023507	COLLAR	1	1
9	90U-206	842645023538	BOLT M6 ×30	2	3
10	90U-207	842645023613	GASKET, FUEL TANK(II)	1	1
11	90U-208	842645023828	WASHER 6	2	3
12	90U-209	842645023934	OIL LEAD PIPE, FUEL COCK	1	1
13	90U-210	842645024108	CLIP, OIL PIPE	1	2
14	90U-211	842645024191	DAMPER, LOCATING 1	1	1
15	90U-212	842645024450	DAMPER	1	1

FRONT WHEEL					
					
					
Item No.	Part No.	UPC Number	Description	Qty per Order	Qty.
1	90U-214	842645024566	DRUM, FRONT BRAKE	1	1
2	90U-215	842645024597	BOLT	5	8
3	90U-216	842645024610	TUBE, FRONT BRAKE DRUM	1	2
4	90U-217	842645024665	OIL SEAL B6003	1	1
5	90U-218	842645024719	OIL SEAL 20× 35× 7	1	2
8	90U-219	842645024726	RUBBER GASKET	1	2
11	90U-220	842645024733	COLLAR	1	2
12	90U-221	842645024764	NUT CASTLE M14× 1.5	1	2
6	90U-222	842645024788	WHEEL COMP 5.5AT	1	2
7	90U-223	842645024825	NUT, FLANGE M8	5	8
9	90U-224	842645024832	TIRE FRONT (19X77-8)	1	2
10	90U-225	842645024856	VALVE STEM	1	1
13	90U-226	842645024894	PIN, COTTER 3.5× 40	1	2
14			PLATE, BRAKE SHOE	1	1/1
15			BRAKE SHOE SET (1 SET)	1	4
16	90U-227	842645024900	BRAKE, SPRING	3	4

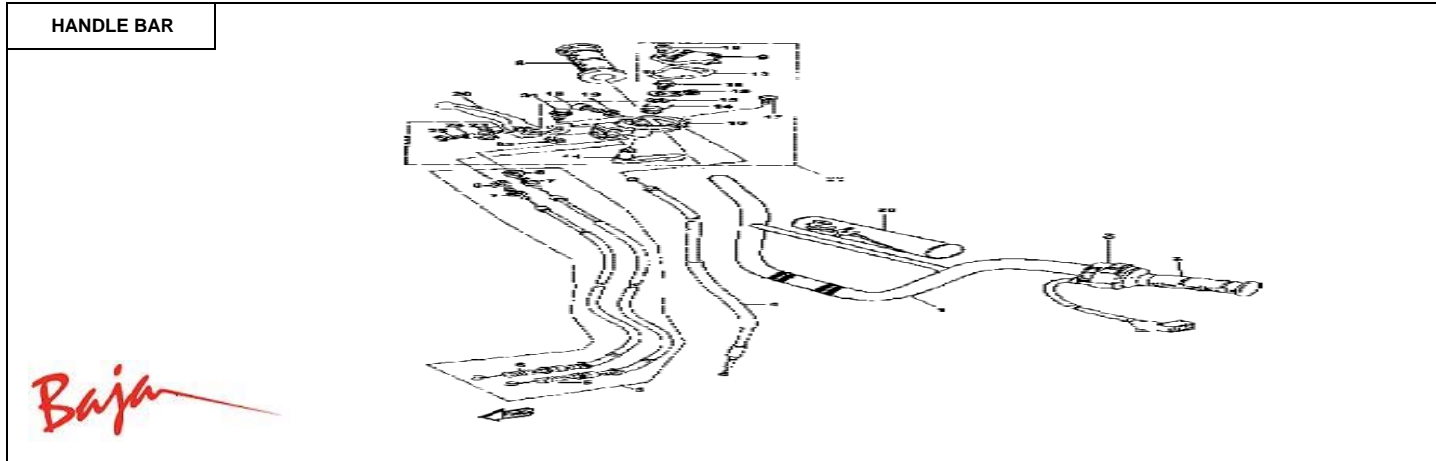
HANDLE BAR					
					
					
Item No.	Part No.	UPC Number	Description	Qty per Order	Qty.
1	90U-238	842645025273	HANDLEBAR	1	1
2	90U-239	842645025297	GRIP	1	2
3	90U-240	842645025532	SWITCH, LEFT HANDLEBAR	1	1
4	90U-241	842645025563	CABLE, THROTTLE 1	1	1
5	90U-242	842645025600	CABLE, FRONT BRAKE	1	2
6			FRONT BRAKE CABLE DUSTPROOF	1	2
7			BOLT, FRONT BRAKE CABLE	1	2
8			TUBE, FRONT BRAKE CABLE	1	2
9			CAP, GEAR	1	1
10			LEVER SET, THROTTLE	1	1
11			LEVER, THROTTLE	1	1
12			ARM, THROTTLE	1	1
13			GASKET	1	1
14			SPRING, TORSION	1	1
15			WASHER 20	1	2
16			BOLT, M8 x12	1	1

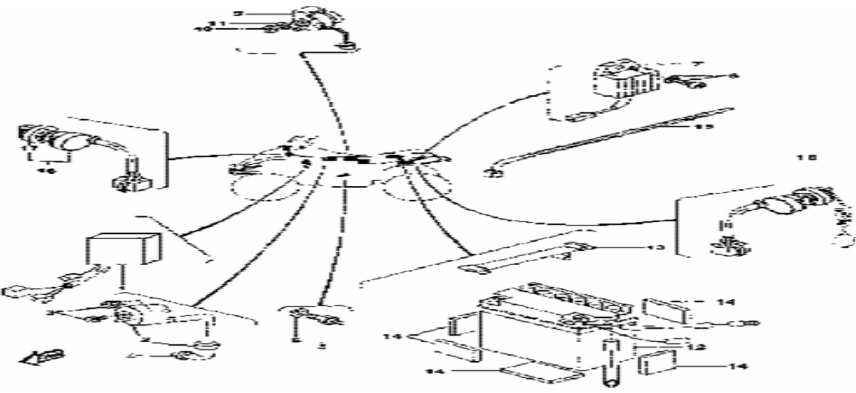

Item No.	Part No.	UPC Number	Description	Qty per Order	Qty.
17			SCREW, PAN HEAD M4×10	1	1
18			BOLT M5 ×16	1	1
19			NUT M5	1	1
20	90U-243	842645025648	R.LEVER	1	1
21			BOLT M6	1	1
22			NUT, M6	1	1
23			JOINT, CABLE	1	1
24			COLLAR, BRAKE CABLE	1	1
25			BOLT, FLANGE M6×16	1	1
26	90U-244	842645025709	HANDLEBAR PROTECTOR	1	1
28	90U-245	842645025723	R.BRAKE HANDLE ASSY	1	1

ELECTRICAL					
					
					
Item No.	Part No.	UPC Number	Description	Qty per Order	Qty.
1	90U-254	842645026027	C.D.I.	1	1
2	90U-255	842645026041	IGNITION COIL ASSY	1	1
3	90U-256	842645026065	SCREW, M6× 20	1	2
4		842645026089	PLUG CAP ASSY		
5	90U-258	842645026096	SWITCH, REAR BRAKE	1	1
6	90U-259	842645026102	GASKET, REAR BRAKE SWITCH	1	1
7	90U-260	842645026119	REGULATOR	1	1
8	90U-261	842645026126	SCREW, M6 × 20	1	1
9	90U-262	842645026133	STARTER RELAY ASSY	1	1
10	90U-263	842645026140	NUT M6	1	1
11	90U-264	842645026157	WASHER, SPRING 6	1	1
12	20-01-9001	842645026171	BATTERY ASSY 5AH.12V	1	1
13	90U-266	842645026188	BAND, BATTERY	1	1
14	90U-267	842645026195	SEAT, BATTERY	3	5
15					15
16	90U-269	842645026218	MAIN SWITCH ASSY	1	1

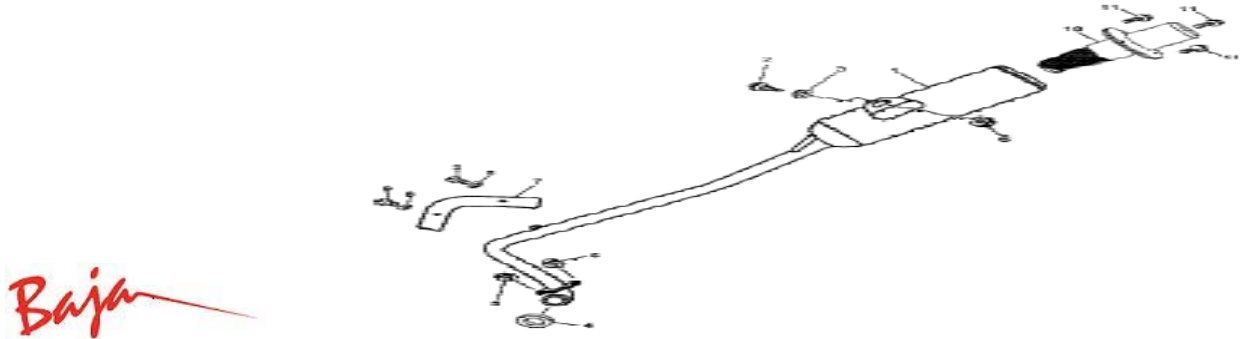
EXHAUST MUFFLER					
					
Item No.	Part No.	UPC Number	Description	Qty per Order	Qty.
1	90U-274	842645026263	EXHAUST MUFFLER	1	1
2	90U-275	842645026270	BOLT, M8×30	1	2
3	90U-276	842645026287	WASHER, 8	1	2
4	90U-277	842645026294	GASKET, EXHAUST PIPE	1	1
5	90U-278	842645026300	NUT, EXHAUST CONNECTION PLATE	1	2
6	90U-279	842645026317	NUT M8	1	1
7	90U-280	842645026324	SHIELD, EXHAUST PIPE	1	1
8	90U-281	842645026331	GASKET 6	1	2
9	90U-282	842645026355	BOLT M6×8	1	2
10	90U-283	842645026362	SPARK COLLECTOR	1	1
11	90U-284	842645026393	BOLT M6×10	2	3

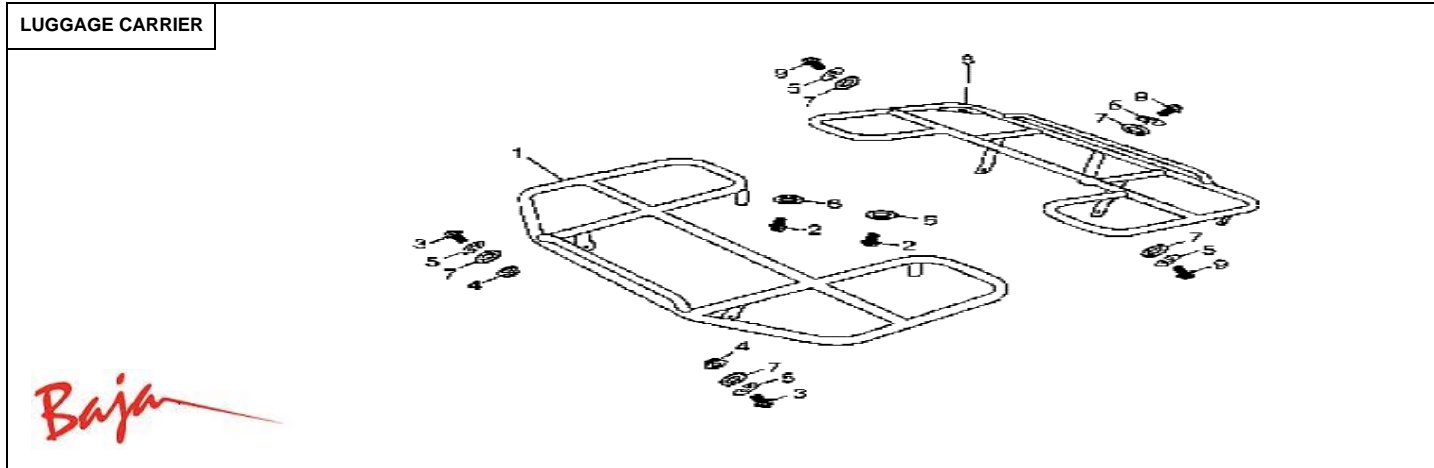

Item No.	Part No.	UPC Number	Description	Qty per Order	Qty.
1	90U-290	842645026485	FRONT LUGGAGE CARRIER	1	1
2	90U-291	842645026492	BOLT M6× 20	1	2
3	90U-292	842645026508	BOLT M8× 25	1	2
4	90U-293	842645026522	NUT M8	1	2
5	90U-294	842645026539	SPRING WASHER 8	3	5
6	90U-295	842645026546	WASHER 6	1	2
7	90U-296	842645026683	WASHER 8	3	5
8	90U-297	842645026744	REAR LUGGAGE CARRIER	1	1
9	90U-298	842645026751	BOLT M8× 20	2	3

FOOT REST					
Item No.	Part No.	UPC Number	Description	Qty per Order	Qty.
1	90U-299	842645026775	FOOT REST, LEFT	1	1
2	90U-300	842645026782	FOOT REST, RIGHT	1	1
3	90U-301	842645026805	BOLT M6 × 20	3	4
4	90U-302	842645026898	WASHER 6	3	4
5	90U-303	842645026928	SCREW M5 × 16	5	8
6	90U-304	842645026942	NUT M5	5	8

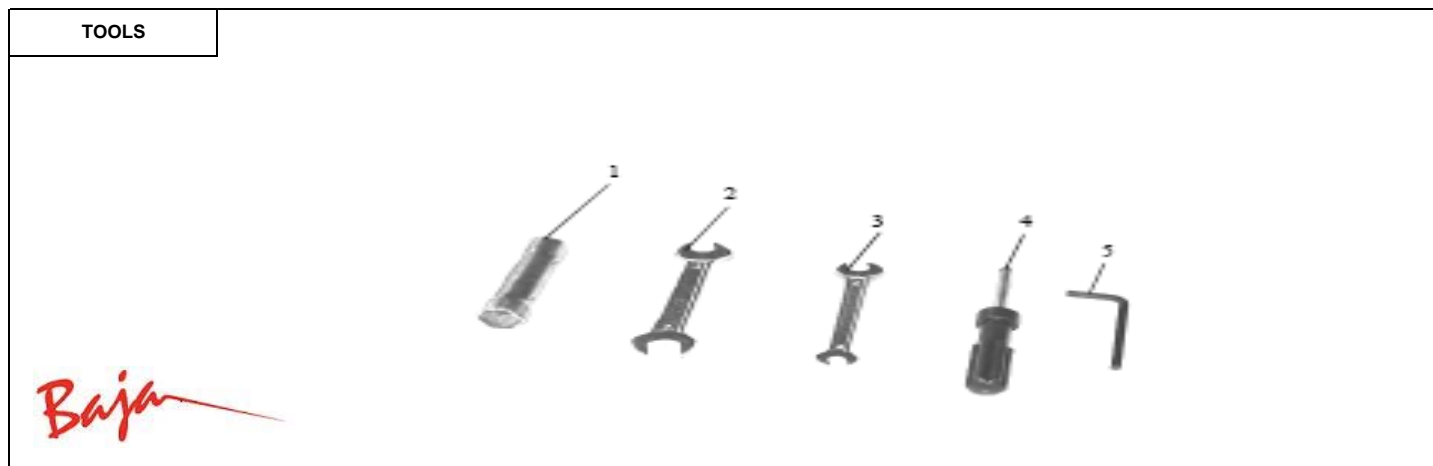

Item No.	Part No.	UPC Number	Description	Qty per Order	Qty.
1			SLEEVE(16-18)	1	1
2			SPANNER(12-14)	1	1
3			SPANNER(8-10)	1	1
4			SCREW DRIVER	1	1
5			WRENCH 5	1	1
	90U-305	842645026959	TOOL KIT	1	1SET